



### Driver LC 50W 350–1050mA 54V 0-10V Ip EXC UNV

Linear excite series

#### Product description

- Constant current LED Driver
- Only for US applications
- Dimmable via 0 ... 10 V interface
- Dimming range 1 – 100 %
- Class 2
- UL Listed Class P
- FCC Part 15
- Adjustable output current between 350 and 1,050 mA via ready2mains Programmer or I-SELECT 2 plugs
- Max. output power 50 W
- Up to 90.6 % efficiency
- Up to 100,000 hrs lifetime
- 5-year guarantee

#### Housing properties

- Low-profile reflective white metal casing
- Type of protection IP20
- Dry and damp location

#### Functions

- Adjustable output current in 1-mA-steps (ready2mains, I-SELECT 2)
- Dimmable via 0 ... 10 V interface
- Protective features (overtemperature, short-circuit, overload, no-load, input voltage range)

#### Benefits

- Operating window for maximum compatibility
- Added energy savings with dimming via 0 ... 10 V interface
- Configurable via ready2mains and I-SELECT 2
- Tailor your dimming response with either Linear or Logarithmic Dimming Curves

#### Typical applications

- For linear/area lighting in office, education, healthcare, and general lighting applications

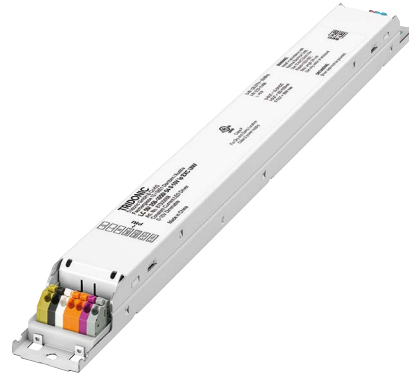

Standards, page 5

### Driver LC 50W 350–1050mA 54V 0-10V Ip EXC UNV

Linear excite series

#### Technical data

Rated supply voltage	120 – 277 V
AC voltage range	108 – 305 V
Mains frequency	50 / 60 Hz
Typ. current (at 120 V, 60 Hz, full load) <sup>①</sup> ②	474 mA
Typ. current (at 277 V, 60 Hz, full load) <sup>①</sup> ②	213 mA
Leakage current (at 120 V, 60 Hz, full load) <sup>①</sup> ②	< 700 µA
Leakage current (at 277 V, 60 Hz, full load) <sup>①</sup> ②	< 700 µA
Max. input power (at 120 V, 60 Hz, full load)	56.3 W
Max. input power (at 277 V, 60 Hz, full load)	55.2 W
Typ. efficiency (at 120 V, 60 Hz, full load) <sup>②</sup>	89.4 %
Typ. efficiency (at 277 V, 60 Hz, full load) <sup>②</sup>	90.6 %
λ (at 120 V, 60 Hz, full load) <sup>①</sup>	0.99
λ (at 277 V, 60 Hz, full load) <sup>①</sup>	0.94C
Typ. input current in no-load operation (at 120 V, 60 Hz)	16 mA
Typ. input current in no-load operation (at 277 V, 60 Hz)	30 mA
Typ. input power in no-load operation (at 120 V, 60 Hz)	0.5 W
Typ. input power in no-load operation (at 277 V, 60 Hz)	0.7 W
In-rush current (peak / duration at 120 V)	26.1 A / 197 µs
In-rush current (peak / duration at 277 V)	62.6 A / 164 µs
THD (at 120 V, 60 Hz, full load) <sup>①</sup>	< 10 %
THD (at 277 V, 60 Hz, full load) <sup>①</sup>	< 10 %
Starting time (full load) <sup>①</sup>	≤ 700 ms
Turn off time (full load)	< 30 ms
Hold time (power failure, full load)	< 20 ms
Output current tolerance <sup>①</sup> ②	± 5 %
Max. output current peak (non-repetitive)	≤ output current + 35 %
Output LF current ripple (< 120 Hz)	± 5 %
Max. output voltage	60 V
Dimming range	1 – 100 %
Mains surge capability (between L - N)	2.5 kV
Mains surge capability (between L/N - PE)	2.5 kV
Surge voltage at output side (against PE)	500 V
Type of protection	IP20
Life-time	up to 100,000 h
Dimensions L x W x H	14.17 x 1.2 x 0.94 inch

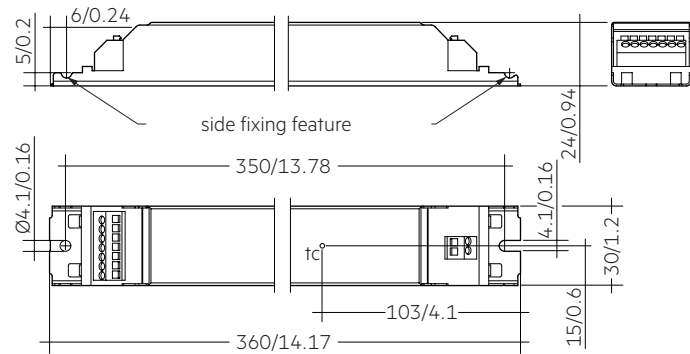

Dimensions in mm / inch

#### Ordering data

Type	Article number	Packaging carton	Packaging, low volume	Packaging, high volume	Weight per pc.
LC 50/350-1050/54 0-10V Ip EXC UNV	87500688	20 pc(s).	260 pc(s).	1,560 pc(s).	0.776 lbs

## Specific technical data

Type	Output current <sup>①</sup> forward voltage	Min. forward voltage	Max. forward voltage	Max. output power (at 120 V, 60 Hz, full load)	Typ. power consumption (at 120 V, 60 Hz, full load)	Typ. current consumption (at 120 V, 60 Hz, full load)	Max. output power (at 277 V, 60 Hz, full load)	Typ. power consumption (at 277 V, 60 Hz, full load)	Typ. current consumption (at 277 V, 60 Hz, full load)	tc temperature <sup>②</sup>	Ambient temperature ta max.	I-SELECT 2 resistor value <sup>④</sup>
LC 50/350-1050/54 0-10V Ip EXC UNV	350 mA	18 V	54.0 V	18.9 W	23.2 W	194 mA	18.9 W	23.4 W	110 mA	158 °F	-13 ... +131 °F	open
	400 mA	18 V	54.0 V	21.6 W	25.8 W	214 mA	21.6 W	26.0 W	117 mA	158 °F	-13 ... +131 °F	12.50 kΩ
	450 mA	18 V	54.0 V	24.3 W	29.2 W	242 mA	24.3 W	29.2 W	127 mA	158 °F	-13 ... +131 °F	11.11 kΩ
	500 mA	18 V	54.0 V	27.0 W	31.6 W	276 mA	27.0 W	31.4 W	134 mA	158 °F	-13 ... +131 °F	10.00 kΩ
	550 mA	18 V	54.0 V	29.7 W	34.7 W	302 mA	29.7 W	34.6 W	143 mA	158 °F	-13 ... +131 °F	9.09 kΩ
	600 mA	18 V	54.0 V	32.4 W	37.4 W	319 mA	32.4 W	37.1 W	146 mA	158 °F	-13 ... +131 °F	8.33 kΩ
	650 mA	18 V	54.0 V	35.1 W	40.7 W	342 mA	35.1 W	40.0 W	156 mA	158 °F	-13 ... +131 °F	7.69 kΩ
	700 mA	18 V	54.0 V	37.8 W	43.2 W	369 mA	37.8 W	43.1 W	166 mA	158 °F	-13 ... +131 °F	7.14 kΩ
	750 mA	18 V	54.0 V	40.5 W	46.0 W	392 mA	40.5 W	45.3 W	174 mA	158 °F	-13 ... +131 °F	6.67 kΩ
	800 mA	18 V	54.0 V	43.2 W	48.8 W	416 mA	43.2 W	48.0 W	183 mA	158 °F	-13 ... +131 °F	6.25 kΩ
	850 mA	18 V	54.0 V	45.9 W	51.8 W	440 mA	45.9 W	51.0 W	192 mA	158 °F	-13 ... +131 °F	5.88 kΩ
	900 mA	18 V	54.0 V	48.6 W	54.8 W	466 mA	48.6 W	54.0 W	204 mA	158 °F	-13 ... +131 °F	5.56 kΩ
	950 mA	18 V	52.6 V	50.0 W	56.2 W	479 mA	50.0 W	55.1 W	207 mA	158 °F	-13 ... +131 °F	5.26 kΩ
	1,000 mA	18 V	50.0 V	50.0 W	56.1 W	479 mA	50.0 W	55.1 W	207 mA	158 °F	-13 ... +131 °F	5.00 kΩ
	1,050 mA	18 V	47.6 V	50.0 W	56.1 W	478 mA	50.0 W	55.1 W	207 mA	158 °F	-13 ... +131 °F	short circuit (0 Ω)

<sup>①</sup> Valid at 100 % dimming level.

<sup>②</sup> Depending on the selected output current.

<sup>③</sup> The table only lists a number of possible operating points but does not cover each single point. The output current can be set within the total value range in 1-mA-steps.

<sup>④</sup> Not compatible with I-SELECT (generation 1).

<sup>⑤</sup> Output current is mean value.

<sup>⑥</sup> 5-year guarantee.

**Product description**

- Ready-for-use resistor to set output current value
- Compatible with LED Driver featuring I-SELECT 2 interface; not compatible with I-SELECT (generation 1)
- Resistor is base insulated
- Resistor power 0.25 W
- Current tolerance  $\pm 2\%$  additional to output current tolerance
- Compatible with LED Driver series PRE and EXC

**Example of calculation**

- $R [k\Omega] = 5 V / I_{out} [mA] \times 1000$
- Resistor value tolerance  $\leq 1\%$ ; resistor power  $\geq 0.1 W$ ; base insulation necessary
- When using a resistor value beyond the specified range, the output current will automatically be set to the minimum value (resistor value too big), respectively to the maximum value (resistor value too small)

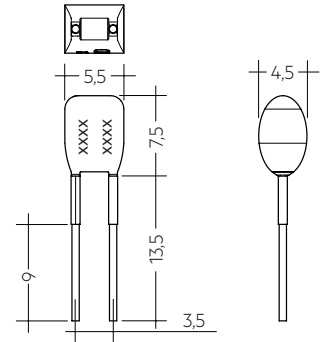
**Ordering data**

Type	Article number	Colour	Marking	Current	Resistor value	Packaging bag	Weight per pc.
I-SELECT 2 PLUG 350MA BL	28001110	Blue	0350 mA	350 mA	14.29 k $\Omega$	10 pc(s).	0.0022 lbs
I-SELECT 2 PLUG 375MA BL	28001111	Blue	0375 mA	375 mA	13.33 k $\Omega$	10 pc(s).	0.0022 lbs
I-SELECT 2 PLUG 400MA BL	28001112	Blue	0400 mA	400 mA	12.50 k $\Omega$	10 pc(s).	0.0022 lbs
I-SELECT 2 PLUG 425MA BL	28001251	Blue	0425 mA	425 mA	11.76 k $\Omega$	10 pc(s).	0.0022 lbs
I-SELECT 2 PLUG 450MA BL	28001113	Blue	0450 mA	450 mA	11.11 k $\Omega$	10 pc(s).	0.0022 lbs
I-SELECT 2 PLUG 475MA BL	28001252	Blue	0475 mA	475 mA	10.53 k $\Omega$	10 pc(s).	0.0022 lbs
I-SELECT 2 PLUG 500MA BL	28001114	Blue	0500 mA	500 mA	10.00 k $\Omega$	10 pc(s).	0.0022 lbs
I-SELECT 2 PLUG 525MA BL	28001960	Blue	0525 mA	525 mA	9.52 k $\Omega$	10 pc(s).	0.0022 lbs
I-SELECT 2 PLUG 550MA BL	28001115	Blue	0550 mA	550 mA	9.09 k $\Omega$	10 pc(s).	0.0022 lbs
I-SELECT 2 PLUG 600MA BL	28001116	Blue	0600 mA	600 mA	8.33 k $\Omega$	10 pc(s).	0.0022 lbs
I-SELECT 2 PLUG 650MA BL	28001117	Blue	0650 mA	650 mA	7.69 k $\Omega$	10 pc(s).	0.0022 lbs
I-SELECT 2 PLUG 700MA BL	28001118	Blue	0700 mA	700 mA	7.14 k $\Omega$	10 pc(s).	0.0022 lbs
I-SELECT 2 PLUG 750MA BL	28001119	Blue	0750 mA	750 mA	6.67 k $\Omega$	10 pc(s).	0.0022 lbs
I-SELECT 2 PLUG 800MA BL	28001120	Blue	0800 mA	800 mA	6.25 k $\Omega$	10 pc(s).	0.0022 lbs
I-SELECT 2 PLUG 850MA BL	28001121	Blue	0850 mA	850 mA	5.88 k $\Omega$	10 pc(s).	0.0022 lbs
I-SELECT 2 PLUG 900MA BL	28001122	Blue	0900 mA	900 mA	5.56 k $\Omega$	10 pc(s).	0.0022 lbs
I-SELECT 2 PLUG 950MA BL	28001123	Blue	0950 mA	950 mA	5.26 k $\Omega$	10 pc(s).	0.0022 lbs
I-SELECT 2 PLUG 1000MA BL	28001124	Blue	1000 mA	1000 mA	5.00 k $\Omega$	10 pc(s).	0.0022 lbs
I-SELECT 2 PLUG 1050MA BL	28001125	Blue	1050 mA	1050 mA	4.76 k $\Omega$	10 pc(s).	0.0022 lbs
I-SELECT 2 PLUG MAX BL	28001099	Blue	MAX	MAX	0.00 k $\Omega$	10 pc(s).	0.0022 lbs

## 1. Standards

UL 8750  
CSA C22.2  
FCC Part 15, Class A

Product not designed for European Economic Area.

This device complies with Part 15 of the FCC Rules. Operation is subject to the following two conditions:

- (1) this device may not cause harmful interference, and
- (2) this device must accept any interference received, including interference that may cause undesired operation.

## 2. Thermal details and life-time

### 2.1 Expected life-time

#### Expected life-time 120 V

Type	Output current	ta	45 °C / 113 °F	50 °C / 122 °F	55 °C / 131 °F
LC 50/350-1050/54 0-10V Ip EXC UNV	350 – 1,050 mA	tc	55 °C / 131 °F	65 °C / 149 °F	70 °C / 158 °F
		Life-time	> 100,000 h	70,000 h	50,000 h

#### Expected life-time 277 V

Type	Output current	ta	45 °C / 113 °F	50 °C / 122 °F	55 °C / 131 °F
LC 50/350-1050/54 0-10V Ip EXC UNV	350 – 1,050 mA	tc	55 °C / 131 °F	65 °C / 149 °F	70 °C / 158 °F
		Life-time	> 100,000 h	> 100,000 h	80,000 h

The LED Driver is designed for a life-time stated above under reference conditions and with a failure probability of less than 10 %.

#### Life-time vs. tc:

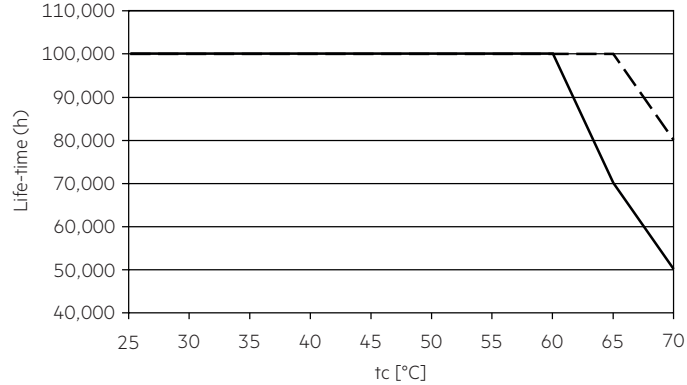

— 120 V  
- - - 277 V

### 3. Installation / wiring

#### 3.1 Circuit diagram

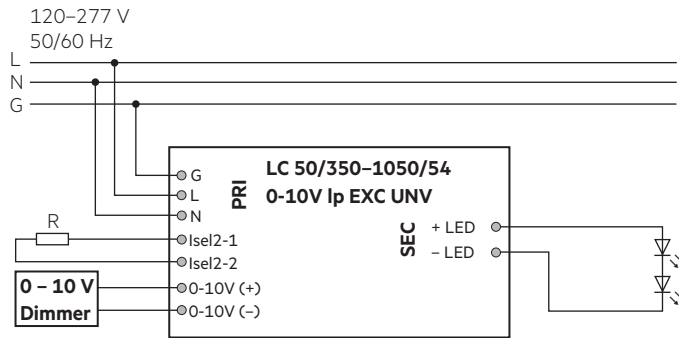

#### 3.2 Wiring type and cross section

The wiring can be in stranded wires with ferrules or solid with a cross section of 0.2–1.5 mm<sup>2</sup> / 24 – 16 AWG.

According to safety standard to choose an AWG.

Strip 8.5–9.5 mm / 3/8 inch of insulation from the cables to ensure perfect operation of the push-wire terminals.

Use one wire for each terminal connector only.

LED module/LED Driver/supply

wire preparation:  
0.2 – 1.5 mm<sup>2</sup>

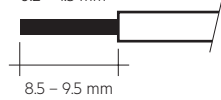

#### 3.3 Loose wiring

Press down the “push button” and remove the cable from front.

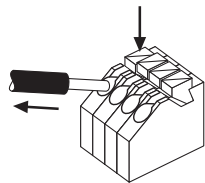

#### 3.4 Wiring guidelines

- The cables should be run separately from the mains connections and mains cables to ensure good EMC conditions.
- The LED wiring should be kept as short as possible to ensure good EMC. The max. secondary cable length is 2 m / 6.56 ft (4 m / 13.12 ft circuit).
- Secondary switching is not permitted.
- The LED Driver has no inverse-polarity protection on the secondary side. Wrong polarity can damage LED modules with no inverse-polarity protection.
- Wrong wiring of the LED Driver can lead to malfunction or irreparable damage.
- To avoid the damage of the Driver, the wiring must be protected against short circuits to earth (sharp edged metal parts, metal cable clips, louver, etc.).

#### 3.5 Hot plug-in

Hot plug-in is not supported due to residual output voltage of > 0 V.

If a LED load is connected, the device has to be restarted before the output will be activated again.

This can be done via mains reset or via interface ready2mains.

#### 3.6 Earth connection

The earth connection is conducted as protection earth (PE). If the LED Driver will be earthed, protection earth (PE) has to be used. There is no earth connection required for the functionality of the LED Driver.

Earth connection is recommended to improve following behaviour:

- Electromagnetic interferences (EMI)
- Transmission of mains transients to the LED output

In general it is recommended to earth the LED Driver if the LED module is mounted on earthed luminaire parts respectively heat sinks and thereby representing a high capacity against earth.

#### 3.7 I-SELECT 2 resistors connected via cable

For details see:

[http://www.tridonic.com/com/en/download/technical/LCA\\_PRE\\_LC\\_EXC\\_ProductManual\\_en.pdf](http://www.tridonic.com/com/en/download/technical/LCA_PRE_LC_EXC_ProductManual_en.pdf)

## 4. Electrical values

#### 4.1 Operating window

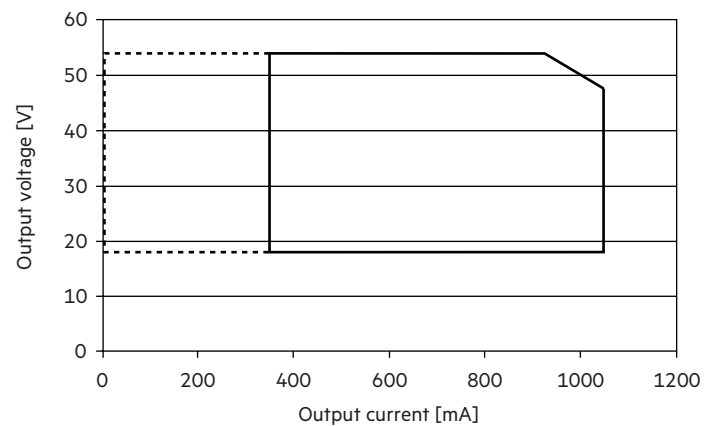

- Operating window 100 %
- - - - - Operating window dimmed

Make sure that the LED Driver is operated within the given window under all operating conditions. Special attention needs to be paid at dimming as the forward voltage of the connected LED modules varies with the dimming level, due to the implemented amplitude dimming technology. Coming below the specified minimum output voltage of the LED Driver may cause the device to shut-down.

4.2 Efficiency vs load

120 V, 60 Hz:

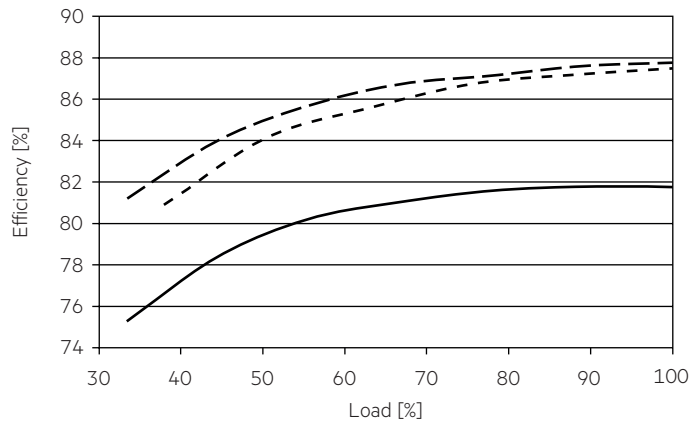

277 V, 60 Hz:

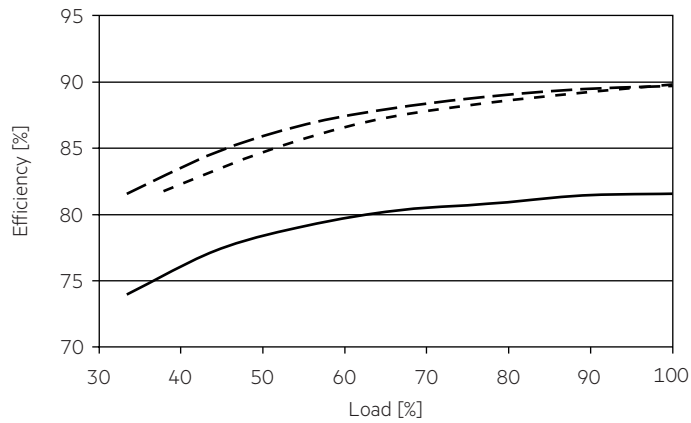

4.3 Power factor vs load

120 V, 60 Hz:

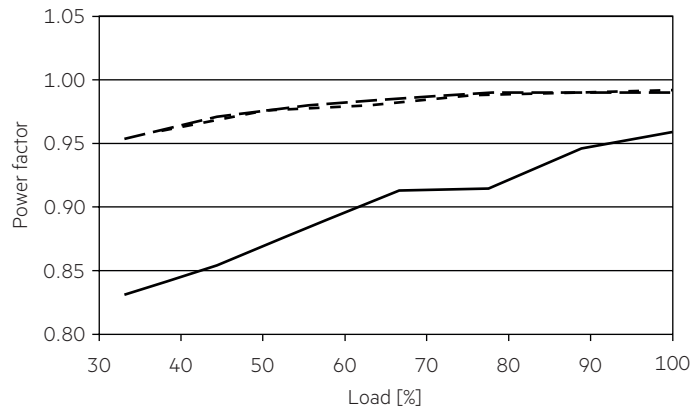

277 V, 60 Hz:

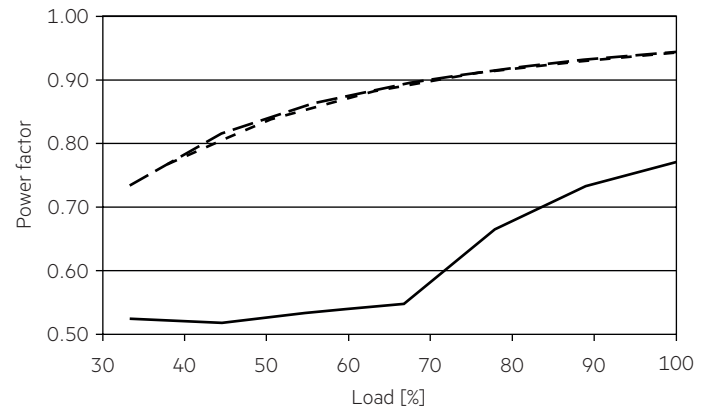

4.4 THD vs load (without harmonic < 5 mA or 0.6 % of the input current)

120 V, 60 Hz:

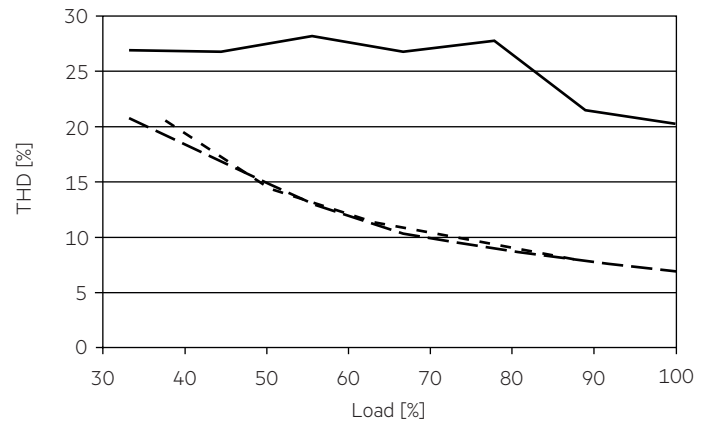

277 V, 60 Hz:

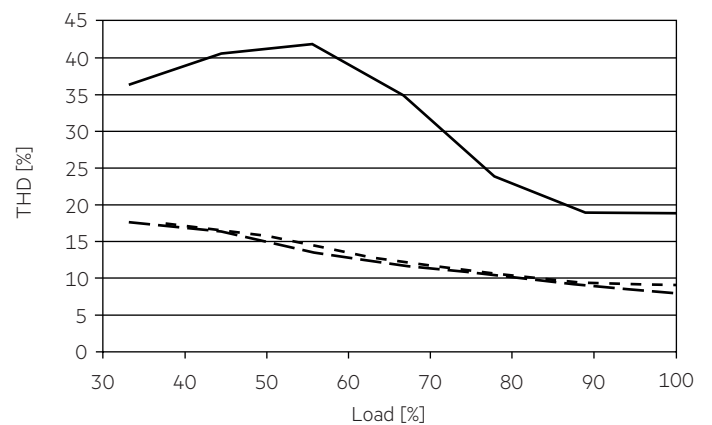

- 350 mA
- - - 950 mA
- · - · 1050 mA

100 % load corresponds to the max. output power (full load) according to the table on page 3.

#### 4.5 Maximum loading of automatic circuit breakers in relation to inrush current

120 V, 60 Hz:

Automatic circuit breaker type	C10	C13	C16	C20	B10	B13	B16	B20	Inrush current	
Installation Ø	1.5 mm <sup>2</sup> / AWG16	1.5 mm <sup>2</sup> / AWG16	2.5 mm <sup>2</sup> / AWG14	2.5 mm <sup>2</sup> / AWG14	1.5 mm <sup>2</sup> / AWG16	1.5 mm <sup>2</sup> / AWG16	2.5 mm <sup>2</sup> / AWG14	2.5 mm <sup>2</sup> / AWG14	$I_{max}$	time
<b>LC 50/350-1050/54 0-10V Ip EXC UNV</b>	28	36	46	61	17	22	28	37	26.1 A	197 µs

277 V, 60 Hz:

Automatic circuit breaker type	C10	C13	C16	C20	B10	B13	B16	B20	Inrush current	
Installation Ø	1.5 mm <sup>2</sup> / AWG16	1.5 mm <sup>2</sup> / AWG16	2.5 mm <sup>2</sup> / AWG14	2.5 mm <sup>2</sup> / AWG14	1.5 mm <sup>2</sup> / AWG16	1.5 mm <sup>2</sup> / AWG16	2.5 mm <sup>2</sup> / AWG14	2.5 mm <sup>2</sup> / AWG14	$I_{max}$	time
<b>LC 50/350-1050/54 0-10V Ip EXC UNV</b>	11	15	18	23	7	9	11	14	62.6 A	164 µs

This are max. values calculated out of inrush current! Please consider not to exceed the maximum rated continuous current of the circuit breaker.

Calculation uses typical values from ABB series S200 as a reference.

Actual values may differ due to used circuit breaker types and installation environment.

#### 4.6 Dimming

Dimming range is 1 to 100%.

The operating window shows the minimum reachable power in dimmed state.

#### 4.7 Dimming characteristics

##### Control input (0 – 10 V)

Control input open	max. dimming level
Control input short-circuited	min. dimming level
Interface current range	400 – 500 µA
Max. permitted input voltage	± 16 V
Voltage range dimming	0 – 10 V <sup>Ⓣ</sup>
Input voltage < 1 V	min. dimming level <sup>Ⓣ</sup>
Input voltage > 10 V	max. dimming level <sup>Ⓣ</sup>

Interface supports current sink dimmers.

<sup>Ⓣ</sup> See graph below (at full load):

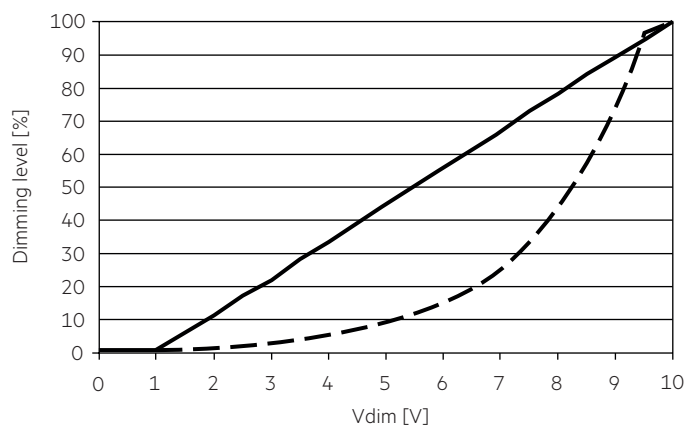

- Linear dimming curve (default)
- - - Logarithmic dimming curve  
(selectable via ready2mains programmer)

## 5. Interfaces / communication

### 5.1 Control input ready2mains (L, N)

The digital ready2mains protocol is modulated onto the mains signal which is wired to the mains terminal (L and N).

## 6. Functions

### 6.1 Function: adjustable current

The output current of the LED Driver can be adjusted in a certain range. For adjustment there are two options available.

Option 1: I-SELECT 2

By inserting a suitable resistor or third party resistor into the I-SELECT 2 interface, the current value can be adjusted. The relationship between output current and resistor value can be found in the chapter "Accessories I-SELECT 2 Plugs".



Please note that the resistor values for I-SELECT 2 are not compatible with I-SELECT (generation 1). Installation of an incorrect resistor may cause irreparable damage to the LED module(s).

Resistors for the main output current values can be ordered from Tridonic (see accessories).

Option 2: ready2mains

Adjustment is done by the ready2mains Programmer and the corresponding configuration software (see ready2mains documentation).

The priority for current adjustment methods is I-SELECT 2 followed by ready2mains (lowest priority).



## 6.2 ready2mains – configuration

The ready2mains interface enables the configuration of the mostly used parameters via the mains wiring.

In the case of EXC LED Driver, it is the LED output current as well as an optional lockbit to prevent any accidental configuration at a later stage.

The configuration is done via the ready2mains Programmer, either directly at the Programmer itself or via a respective software tool. For details on the configuration via ready2mains see the technical information of the Programmer and its tools.

## 6.3 Short-circuit behaviour

In case of a short-circuit at the LED output the LED output is switched off. After restart of the LED Driver the output will be activated again. The restart can either be done via mains reset or via interface ready2mains.

## 6.4 No-load operation

The LED Driver will not be damaged in no-load operation. The output will be deactivated and is therefore free of voltage. If a LED load is connected the device has to be restarted before the output will be activated again.

## 6.5 Overload protection

If the output voltage range is exceeded the LED Driver turns off the LED output. After restart of the LED Driver the output will be activated again. The restart can either be done via mains reset or via interface ready2mains.

## 6.6 Overtemperature protection

The LED Driver is protected against temporary thermal overheating. Thermal overload protection is triggered if the maximum Tc temperature is exceeded by around 41 to 50 °F (see page 3) and the output current is slowly reduced. The LED Driver can cool down with still having light.

## 7. Miscellaneous

### 7.1 Insulation and electric strength testing of luminaires

Electronic devices can be damaged by high voltage. This has to be considered during the routine testing of the luminaires in production.

According to UL 8750 (informative only!) each luminaire should be submitted to an insulation test with 500V<sub>DC</sub>. The dielectric withstand test equipment shall employ a transformer of 500-VA or larger capacity and have a variable output voltage that is essentially sinusoidal or continuous direct current. The applied potential is to be increased from zero at a substantially uniform rate until the required test level is reached, and is to be held at that level for 1 minute.

As an alternative, UL8750 (informative only!) describes a test of the electrical strength with 2V AC + 1000V (or 1.414 x V DC). To avoid damage to the electronic devices this test must not be conducted.

### 7.2 Conditions of use and storage

Humidity: 5% up to max. 85%,  
not condensed  
(max. 56 days/year at 85%)

Storage temperature: -40 °F up to max. +176 °F

The devices have to be acclimatised to the specified temperature range (ta) before they can be operated.

### 7.3 Maximum number of switching cycles

All LED Driver are tested with 50,000 switching cycles.  
The actually achieved number of switching cycles is significantly higher.

### 7.4 Additional information

Additional technical information at [www.tridonic.com](http://www.tridonic.com) → Technical Data

Guarantee conditions at [www.tridonic.com](http://www.tridonic.com) → Services

Life-time declarations are informative and represent no warranty claim.  
No warranty if device was opened.